

JVC VIDEO CASSETTE RECORDER HR-J481MS



INSTRUCTIONS

LPT0591-001A
COPYRIGHT © 2001 VICTOR COMPANY OF JAPAN, LTD.

MS Printed in Malaysia
0501 MNV*PJ*PJ

Safety Precautions

The rating plate and the safety caution are on the rear of the unit.

WARNING: DANGEROUS VOLTAGE INSIDE

WARNING: TO PREVENT FIRE OR SHOCK HAZARD, DO NOT EXPOSE THIS UNIT TO RAIN OR MOISTURE.

CAUTION

- When you are not using the recorder for a long period of time, it is recommended that you disconnect the power cord from the mains outlet.
- Dangerous voltage inside. Refer internal servicing to qualified service personnel. To prevent electric shock or fire hazard, remove the power cord from the mains outlet prior to connecting or disconnecting any signal lead or aerial.

ATTENTION

1. This recorder can also receive SECAM colour television signals for recording and playback.
2. Recordings made of SECAM television signals produce monochrome pictures if played back on another video recorder of SECAM standard, or do not produce normal colour pictures if played back on another video recorder of PAL standard.
3. SECAM prerecorded cassettes or recordings made with a SECAM video recorder produce monochrome pictures when played back with this recorder.

POWER SYSTEM:

This set operates on voltage of AC110 – 240 V~ (Rating), AC90 – 260 V~ (Operating), 50/60 Hz with automatic switching.

Caution on Replaceable lithium battery

The battery used in this device may present a fire or chemical burn hazard if mistreated. Do not recharge, disassemble, heat above 100°C or incinerate.

Replace battery with Panasonic (Matsushita Electric), Sanyo, Sony or Maxell CR2025. Danger of explosion or Risk of fire if the battery is incorrectly replaced.

- Dispose of used battery promptly.
- Keep away from children.
- Do not disassemble and do not dispose of in fire.

IMPORTANT

- Please read the various precautions on this page before installing or operating the recorder.
- It should be noted that it may be unlawful to re-record pre-recorded tapes, records, or discs without the consent of the owner of copyright in the sound or video recording, broadcast or cable programme and in any literary, dramatic, musical, or artistic work embodied therein.

The STANDBY/ON ϕ /I button does not completely shut off mains power from the unit, but switches operating current on and off. " ϕ /I" shows electrical power standby and "I" shows ON.

Video tapes recorded with this video recorder in the LP (Long Play) or EP (Extended Play) mode cannot be played back on a single-speed video recorder.



- Cassettes marked "VHS" (or "S-VHS") can be used with this video cassette recorder. However, S-VHS recording is not possible with this model.
- This model is equipped with SQPB (S-VHS QUASI PLAYBACK) that makes it possible to play back S-VHS recordings with regular VHS resolution.
- HQ VHS is compatible with existing VHS equipment.

When the equipment is installed in a cabinet or a shelf, make sure that it has sufficient space on all sides to allow for ventilation (10 cm or more on both sides, on top and at the rear).

When discarding batteries, environmental problems must be considered and the local rules or laws governing the disposal of these batteries must be followed strictly.

Failure to heed the following precautions may result in damage to the recorder, remote control or video cassette.

- DO NOT place the recorder ...
 - ... in an environment prone to extreme temperatures or humidity.
 - ... in direct sunlight.
 - ... in a dusty environment.
 - ... in an environment where strong magnetic fields are generated.
 - ... on a surface that is unstable or subject to vibration.
- DO NOT block the recorder's ventilation openings or holes. (If the ventilation openings or holes are blocked by a newspaper or cloth, etc., the heat may not be able to get out.)
- DO NOT place heavy objects on the recorder or remote control.
- DO NOT place anything which might spill on top of the recorder or remote control. (If water or liquid is allowed to enter this equipment, fire or electric shock may be caused.)
- DO NOT expose the apparatus to dripping or splashing.
- DO NOT use this equipment in a bathroom or places with water. Also DO NOT place any containers filled with water or liquids (such as cosmetics or medicines, flower vases, potted plants, cups, etc.) on top of this unit.
- DO NOT place any naked flame sources, such as lighted candles, on the apparatus.
- AVOID violent shocks to the recorder during transport.

MOISTURE CONDENSATION

Moisture in the air will condense on the recorder when you move it from a cold place to a warm place, or under extremely humid conditions—just as water droplets form on the surface of a glass filled with cold liquid. Moisture condensation on the head drum will cause damage to the tape. In conditions where condensation may occur, keep the recorder's power turned on for a few hours to let the moisture dry.

How to use the remote control

The remote control can operate most of your recorder's functions, as well as basic functions of TV, cable box, satellite receiver, and DVD sets of JVC and other brands.

- Point the remote control toward the sensor window on the target component.
- The maximum operating distance of the remote control is about 8 m.

NOTES:

- When inserting the batteries, be sure to insert in the correct directions as indicated under the battery cover.
- If the remote control does not work properly, remove its batteries, wait for a few seconds, replace the batteries and then try again.

Video heads cleaning

Use a dry cleaning cassette — TCL-2UX — when:

- Rough, poor picture appears while a tape is played back.
- The picture is unclear or no picture appears.
- "USE CLEANING CASSETTE" appears on the screen (only with "O.S.D." set to "ON").

Buttons, Connectors and Indicators

Front Panel

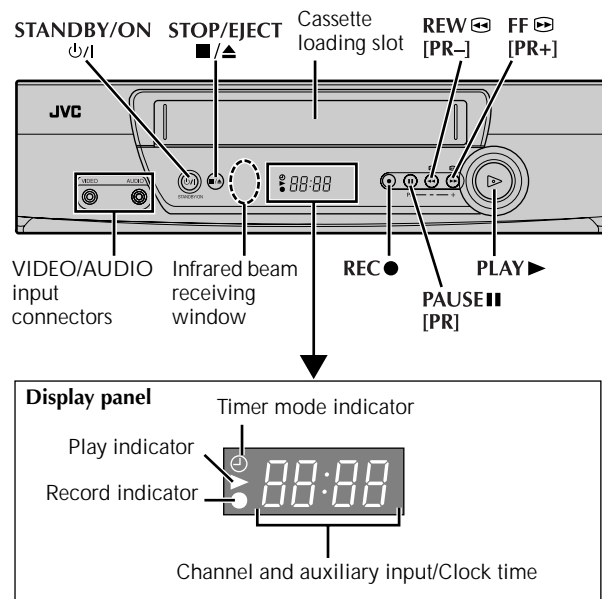

Rear Panel

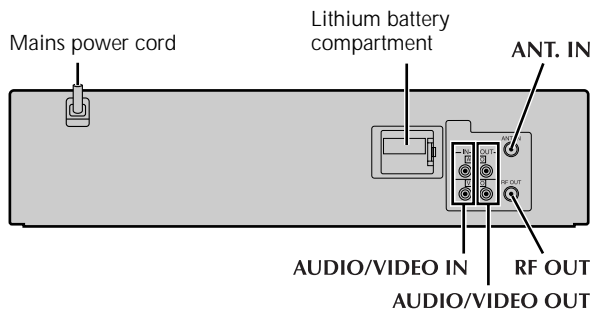

Remote control

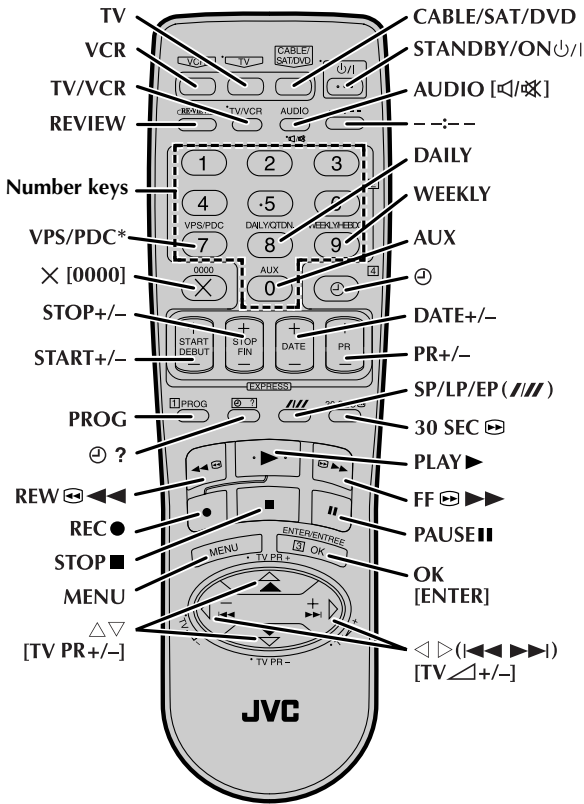

* Not function with this recorder.

On-screen display

If you press **OK** on the remote control when "O.S.D." is set to "ON", you can see the current recorder status on the TV screen. After about 5 seconds, indications other than the time counter disappear. To clear the time counter, press **OK** again. The indications are not recorded even if the recorder is in the recording mode.

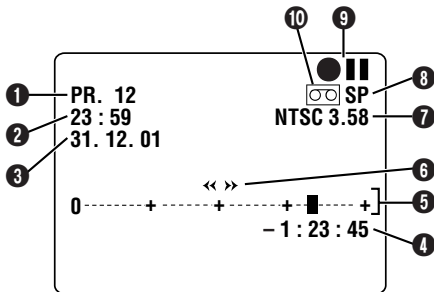

- 1 Channel and auxiliary input
- 2 Clock time
- 3 Day
- 4 Time counter
- 5 Tape position
- 6 Tape direction
- 7 Colour system indicator
- 8 Tape speed
- 9 Recorder operation mode
- 10 Cassette mark

Basic Connections

1 Check contents

Make sure the package contains all of the accessories listed in "Specifications".

2 Situate recorder

Place the recorder on a stable, horizontal surface.

3 Connect recorder to TV

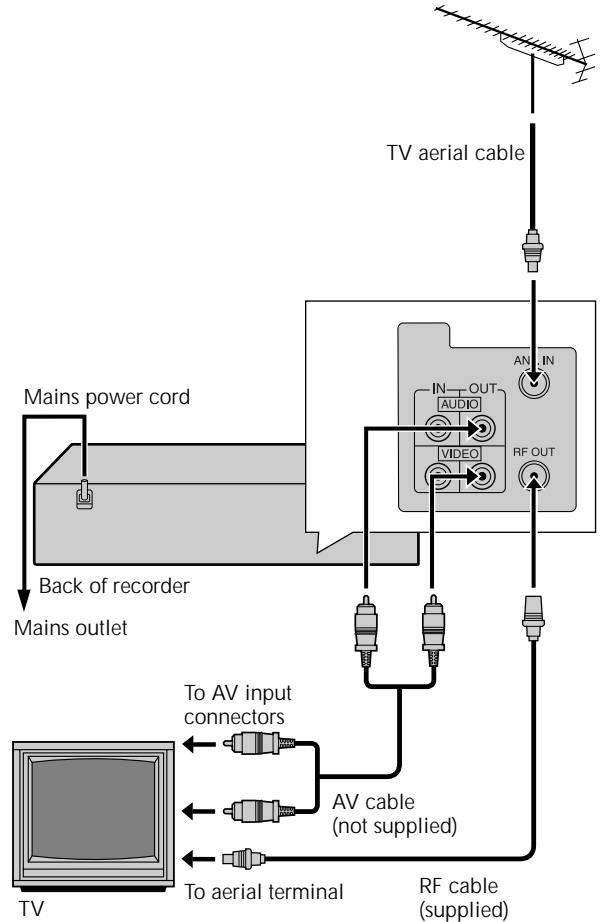

RF Connection

- 1 Disconnect the TV aerial cable from the TV.
- 2 Connect the TV aerial cable to the ANT. IN terminal on the rear of the recorder.
- 3 Connect the supplied RF cable between the RF OUT terminal on the rear of the recorder and the TV's aerial input terminal.

AV Connection

(improves picture quality during tape playback.)

If your TV is equipped with AV input connectors

- 1 Connect the aerial, recorder and TV as shown in the illustration.
 - 2 Connect an AV cable between the AUDIO/VIDEO OUT connectors on the rear of the recorder and the AV input connectors on the TV.
- Even if you are using AV cables to connect your recorder to your TV, you must also connect it using the RF cable. This will ensure that you can record one show while watching another.

4 Connect recorder to mains

Plug the mains power cord into a mains outlet.

Initial Settings

Video Channel Set

Video channel (RF output channel) is the channel on which your TV receives picture and sound signals from the video recorder through the RF cable. Before performing the following steps, make sure the recorder's power is off and there is no cassette inserted in the recorder.

If you have connected the video recorder to your TV via the provided RF cable only (RF connection)...

1 Hold down **STOP/EJECT** (■/▲) on the recorder until the display panel shows the following.



2 Press **PR+** or **-** on the remote control to set appropriate TV system that matches the system of TV being used (refer to the table below).

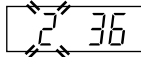

1: B/G 2: D/K 3: I 4: H

Major Countries	TV System
New Zealand, Kuwait, U.A.E., Indonesia, Singapore, Thailand, Malaysia, Iran, Saudi Arabia, Egypt, Morocco, Lebanon, Iraq	B/G
China, Mongolia, Russia	D/K
Hong Kong	I
Australia	H

3 Set your TV to UHF channel 36.

• If the two vertical white bars appear clearly on the screen as shown on the right, press **OK** and then go to step 4.

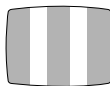

• If the two vertical white bars do not appear clearly, press **OK** and then **PR +** or **-** to set the recorder to a vacant channel between 28 and 60 which is not occupied by any local station in your area.

(Ex.) If channel 50 is available in your area...

Then set your TV to UHF channel 50 and check if the two vertical white bars appear clearly on the screen; if so, go to step 4. If not, re-set the recorder to another vacant channel and try again.

4 Press **OK** to finish video channel set.

If you have connected the video recorder to your TV via both the provided RF cable and an AV cable (AV connection)...

1 Hold down **STOP/EJECT** (■/▲) on the recorder until the display panel shows the following.

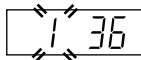

2 Press **OK**, then press **PR -** until the display panel shows the following. Now the video channel is set to off (---).

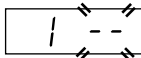

3 Press **OK** to finish video channel set.

• If Auto Set Up or Tuner Set has not previously been performed, the Language Select screen appears and Auto Set Up function takes place automatically.

Installing/Removing the lithium battery

Be sure to connect the power plug to an AC outlet first before installing the lithium battery; otherwise, the battery's service life will be drastically shortened.

1 Make sure that the power plug is connected to an AC outlet and turn off the recorder power.

2 Open the battery cover while pressing the release tab as illustrated.

3 Insert a lithium battery with the plus (+) side up and push it in.
• To remove the lithium battery, press the latch (A) downward using a pointed non-metallic object, then pull out the lithium battery.

4 Close the battery cover until it clicks in place.

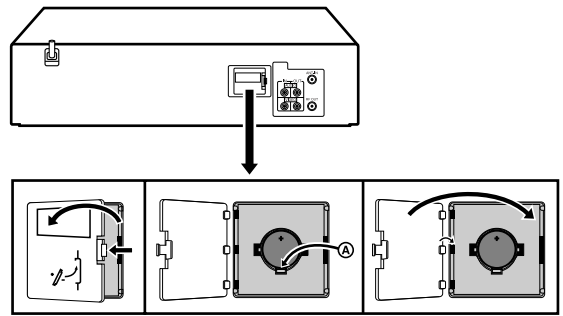

Auto Set Up

The Auto Set Up function simplifies installation by guiding you through the procedures of setting the language, clock and tuner channels — simply follow the on-screen menus that appear.

• Turn on the recorder and the TV, and set your TV to its AV mode or video channel.

1 Select language

Press Δ/∇ to place the pointer next to your desired language (English, Russian or Arabic), then press **OK** or \triangleright .

• The Clock Set screen appears.

2 Set time

Press Δ/∇ to set the hour, then press **OK** or \triangleright .

• Press and hold either button to delay or advance the time by 30 minutes.

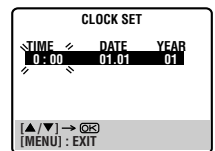

3 Set date

Press Δ/∇ to set the date, then press **OK** or \triangleright .

• Press and hold either button to change the date by 15 days.

4 Set year

Press Δ/∇ to set the year, then press **MENU**.

5 Select TV system

Press Δ/∇ to place the pointer next to the appropriate TV system (refer to the table below).

Major Countries	TV System
Australia, New Zealand, Kuwait, U.A.E., Indonesia, Singapore, Thailand, Malaysia, Iran, Saudi Arabia, Egypt, Morocco, Lebanon, Iraq	B/G
China, Mongolia, Russia	D/K
Hong Kong	I

6 Start auto channel set

Press **OK** or \triangleright .

• Receivable channels in your area are automatically assigned to the **PR+/-** buttons, and non-receivable channels are skipped.

• When Auto Set Up is completed, the lowest position number will appear on the front display panel. If "SCAN COMPLETED—NO SIGNAL—" is displayed on the screen, make sure that the aerial cable is connected to the recorder properly and press **OK** on the remote control. The recorder will try Auto Set Up again.

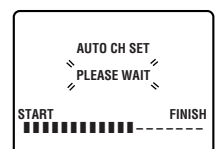

Language Setting

1 Access Main Menu screen, then Initial Set screen

Press **MENU** on the remote control. Press \triangle/∇ to place the pointer next to "INITIAL SET", then press **OK** or \triangleright .

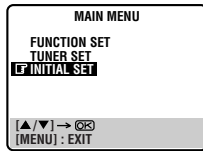

2 Access Language Select screen

Press \triangle/∇ to place the pointer next to "LANGUAGE", then press **OK** or \triangleright .

3 Select language

Press \triangle/∇ to place the pointer next to the language of your choice (English, Russian or Arabic), then press **OK** or \triangleright . Press **MENU** to return to normal screen.

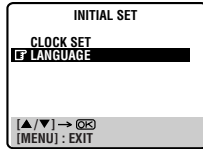

Clock Setting

1 Access Main Menu screen, then Initial Set screen

Press **MENU** on the remote control. Press \triangle/∇ to place the pointer next to "INITIAL SET", then press **OK** or \triangleright .

2 Access Clock Set screen

Press \triangle/∇ to place the pointer next to "CLOCK SET", then press **OK** or \triangleright .

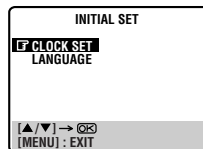

3 Set time, date and year

Press \triangle/∇ until the desired time appears, then press **OK** or \triangleright . Set the date and year in the same way.

- Holding \triangle/∇ changes the time in 30-minute intervals, or changes the date in 15-day intervals.

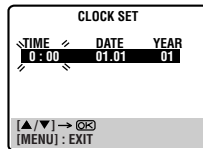

4 Start clock

Press **MENU** and normal screen appears.

NOTE:

If the year digits are automatically cleared, it is possible that you have input February 29th in a non-leap year. Input the correct data.

To make corrections any time during the process

Press **OK** or \triangleright repeatedly until the item you want to change blinks, then press \triangle/∇ .

Playback

Basic Playback

Turn on the TV and select the video channel or AV mode.

1 Load a cassette

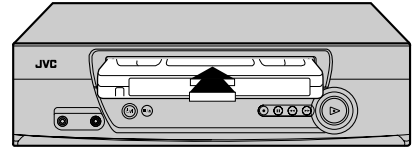

Make sure the window side is up, the rear label side is facing you and the arrow on the front of the cassette is pointing towards the recorder.

- Do not apply too much pressure when inserting.
- The recorder turns on, and the counter on the on-screen display is reset, automatically.
- Select the appropriate colour system with "PAL/MESECAM" and "NTSC" in Function settings.
- If the cassette's record safety tab has been removed, playback begins automatically.

2 Start playback

Press **PLAY** (\blacktriangleright).

ATTENTION

In the search, still, slow-motion or frame-by-frame playback mode,

- *the picture will be distorted.*
- *the noise bars will appear.*
- *there may be a loss of colour.*

During playback

Stop playback

Press **STOP** (\blacksquare) on the remote control. **OR** Press **STOP/EJECT** ($\blacksquare/\blacktriangle$) on the recorder.

Pause playback and view still picture

Press **PAUSE** (\blacksquare).

- Press **PLAY** (\blacktriangleright) to resume normal playback.

Pause and Frame-by-Frame playback

Press **PAUSE** (\blacksquare) to pause, then press \blacktriangleright (or **PAUSE** (\blacksquare)) repeatedly.

- Press **PLAY** (\blacktriangleright) to resume normal playback.

High speed search

Press **REW** (\blacktriangleleft) or **FF** (\blacktriangleright).

- Press **PLAY** (\blacktriangleright) to resume normal playback.
- If you press and hold **REW** (\blacktriangleleft) or **FF** (\blacktriangleright) for more than 2 seconds, simply releasing it cancels the picture search, and normal playback resumes.

Picture search at variable speed (including slow-motion)

Press \triangleleft or \triangleright repeatedly.

- Press **PLAY** (\blacktriangleright) to resume normal playback.
- Each time you press \triangleleft or \triangleright , the playback speed changes. To decrease the speed during picture search, press the opposite direction button repeatedly.
- During still picture, press and hold \triangleright to start forward slow motion playback. When you release the button, still picture resumes. During still picture, holding **PAUSE** (\blacksquare) for more than 2 seconds also starts forward slow motion playback. If you press **PAUSE** (\blacksquare) again, still picture resumes.

When the tape is not running
Rewind/fast-forward
Press REW (◀◀) or FF (▶▶).
Eject the tape
Press STOP/EJECT (■/▲). ● You can also eject the cassette when the recorder is turned off.
Turn off the recorder
Press POWER .

Playback Features

Adjusting tracking condition

— tracking adjustment

Automatic tracking adjustment

Whenever you insert a tape and start playback, automatic tracking starts working and continuously analyzes the signal to enable optimum picture quality during playback.

Manual tracking adjustment

If automatic tracking cannot eliminate noises well during playback, follow the procedures below.

- 1 Press **SP/LP/EP** (///) on the remote control during playback to activate manual tracking.
- 2 Press **PR +** and **-** to eliminate the noises. Press it briefly for a fine adjustment, or press and hold for a coarse adjustment.
 - Press **SP/LP/EP** (///) again to reactivate automatic tracking.

Automatic operations after rewinding

— Next Function Memory

The Next Function Memory “tells” the recorder what to do after rewinding is complete. Ensure that the recorder is in stop mode.

● For Automatic Playback Start

Press **REW** (◀◀), then press **PLAY** (▶) within 2 seconds.

● For Automatic Power Off

Press **REW** (◀◀), then press ⏻ within 2 seconds.

● For Automatic Timer Standby

Press **REW** (◀◀), then press ⏻ within 2 seconds.

NOTE:

It is not possible to select the Automatic Timer Standby function if the cassette's record safety tab is removed.

Playing back tape repeatedly (100 times)

— Repeat Play

During playback, press and hold **PLAY** (▶) for more than 5 seconds. The play indicator (▷) on the display panel starts blinking slowly. To stop playback, press **STOP** (■) on the remote control or **STOP/EJECT** (■/▲) on the recorder.

NOTE:

*Pressing **PLAY** (▶), **REW** (◀◀), **FF** (▶▶) or **PAUSE** (||) also stops repeat playback.*

Locating beginning of recordings

— Index Search

Index codes are placed on the tape at the beginning of each recording when recording on this recorder.

- 1 While the tape is not running, press ◀ or ▷ (◀◀ or ▶▶) on the remote control to start search.
- 2 To access a recording of 2 to 9 index codes away, press ◀ or ▷ (◀◀ or ▶▶) repeatedly until the correct number is displayed on the screen (only if “O.S.D.” is set to “ON”). Playback begins automatically when the desired recording is located.

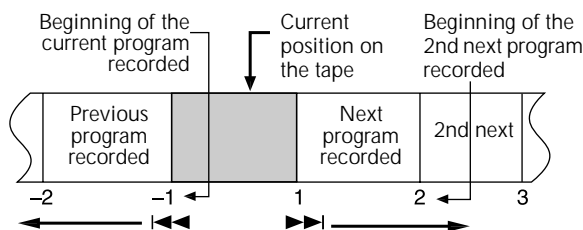
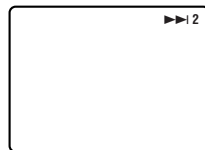

Locating beginning of timer recordings

— Instant Review

After ensuring that the recorder is turned off and that the timer mode is disengaged, press **REVIEW** on the remote control.

- The recorder turns on, and rewinds to the index code indicating the beginning of the last timer-recorded program, then begins playback automatically.
- You can access a program of 2 to 9 index codes away from the current position on the tape. If, for example, you have 5 programs recorded and you want to watch the third one, press **REVIEW** three times.
- The Instant Review function will also operate if the recorder is turned on.

Skipping unwanted portions

— Skip Search

Press **30 SEC** (⏮) on the remote control once to 4 times during playback. Each press initiates a 30-second period of high speed playback (up to 2 minutes). When the specified portion of the tape is skipped, normal playback resumes automatically. To return to normal playback during Skip Search, press **PLAY** (▶).

Recording

Accidental erasure prevention

To prevent accidental recording on a recorded cassette, remove its record safety tab. To record on it later, cover the hole with adhesive tape.

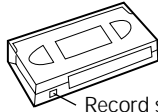

Record safety tab

Basic Recording

Turn on the TV and select the video channel or AV mode.

1 Load a cassette

Make sure the record safety tab is intact. If not, cover the hole with adhesive tape before inserting the cassette.

- The recorder turns on, and the counter is reset, automatically.
- Select the appropriate colour system with "PAL/MESECAM" and "NTSC" in Function settings.

2 Select recording channel

On the remote control

Press **PR+/-** or the **Number** keys.

On the recorder

Press **PAUSE[PR]**. The channel display on the display panel starts blinking. While the display is blinking, press **FF[PR+]** or **REW[PR-]** to select channel. After about 5 seconds, the channel display stops blinking.

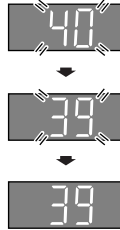

NOTES:

- You can select channel in the stop mode, recording pause mode or during rewind/fast-forward high-speed search.
- If no cassette is loaded, or during recording pause mode, you can select channel only by pressing **FF[CH+]** or **REW[CH-]**.
- If you connect the TV and the recorder only using the RF connection, press **TV/VCR** on the remote control so that the VCR mode indicator lights on the display panel, to view the program to be recorded.

3 Set tape speed

Press **SP/LP/EP (////)**.

4 Start recording

On the recorder, press **REC (●)**. Or on the remote control, while holding **REC (●)**, press **PLAY (▶)**.

- When a tape reaches its end during recording, the recording stops and "○" and "▷" blink on the display panel.

Recording Features

Specifying recording length

— Instant Timer Recording (ITR)

During recording, press **REC (●)** on the recorder repeatedly until the recording length you want appears on the display panel. The record indicator (○) on the display panel starts blinking.

- Each time you press the button, recording length increases in 30-minute intervals (up to 6 hours).
- The recorder shuts off after recording is finished.
- To cancel an ITR, press **STOP (■)** on the remote control or **STOP/EJECT (■/▲)** on the recorder.

Watching one program while recording another

Once recording is in progress, all you need to do is to set the channel controls on the TV for the station you wish to view. The programme selected with the TV's channel controls appears on the TV screen while the one selected with the **PR +/-** buttons is recorded on the tape.

Recording Resume Function

If there is a power outage during recording (or Instant Timer Recording, or timer recording), the recording will resume automatically when the power is restored to the recorder. (No setting is required for this function.)

During recording

Pause recording

Press **PAUSE (||)**.

- Press **PLAY (▶)** to resume recording.

- You can select channel in the recording pause mode.

Stop recording

Press **STOP (■)** on the remote control.

OR Press **STOP/EJECT (■/▲)** on the recorder.

Timer Recording

Up to 8 timer recording programs can be made using Express timer programming method as far as a year in advance. Remember, the clock must be set before you can program the timer.

NOTES:

- If all the 8 programs have already been set, "PROGRAM FULL" appears on the TV screen.
- After timer recording is completed, the recorder turns off automatically.
- You can program the timer recording while a regular recording is in progress; the menu screens will not be recorded.
- In case of a power failure after programming, the recorder's memory backup keeps your selections (if the lithium battery is not exhausted).

Express Timer Programming

- Remember, the clock must be set before you can program the timer.
- Load a cassette with the record safety tab intact. The recorder turns on, and the counter is reset, automatically.
- Select the appropriate colour system with "PAL/MESECAM" and "NTSC" in Function settings.

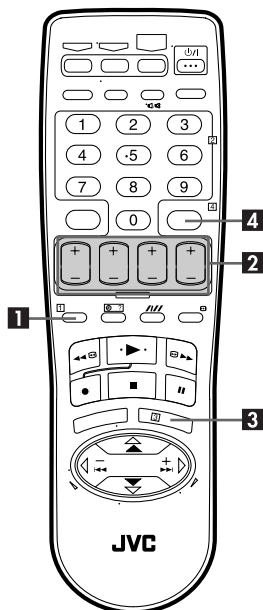

1 Press **PROG** on the remote control to access the Program screen.

2 Press **START+/-**, **STOP+/-**, **DATE+/-** or **PR+/-** repeatedly to enter the start time, stop time, date or channel.

- P1 -	
START	STOP
21:00	--:--
SP	
DATE	TV PROG
--:--	--
[+/-] → [OK]	
[PROG] : EXIT	

- Press and hold **START+/-** or **STOP+/-** to increase the time in 30-minute intervals.
- To set the tape speed, press **SP/LP/EP (///)**.

• To timer-record daily (Monday-Friday) or weekly serials, press **DAILY** or **WEEKLY**. Pressing the button again makes the "DAILY" or "WEEKLY" display disappear.

At the programme check screen...

When the weekly serials are programmed, a day of the week appears. When the daily serials are programmed, "DAILY" appears.

3 Press **OK** or **PROG**.

- If "PROGRAM OVERLAPPED" appears, see "Program overlap warning display".

4 Press **⏻**. The recorder turns off automatically and "⏻" is displayed on the display panel.

- When a tape reaches its end during timer recording, the recording stops and "⏻", "⏻" and "▷" blinks on the display panel.

To use the recorder while it is in timer recording standby mode

Press **⏻**, then press **⏻/I**. After you use the recorder, press **⏻** again to put the recorder into timer recording standby mode.

Checking, canceling or changing program settings

1 Disengage timer

Press **⏻**, then press **⏻/I**.

- When "AUTO TIMER" is set to "ON", you do not have to press **⏻**.

2 Access Program Check screen

Press **⏻ ?**.

PR	START	STOP	CH	DATE
1	8:00	10:00	3	24.04
2	10:00	10:45	2	25.04
3	11:30	13:00	1	25.04
4				
5				
6				
7				
8				
[⏻ ?] : NEXT				

3 Access Program screen

Press **⏻ ?** again. Each time you press **⏻ ?**, the next program's Program screen appears.

- P1 -	
START	STOP
8:00	→ 10:00
SP	
DATE	TV PROG
24.04	3
[⏻ ?] : NEXT	

4 Cancel or change program setting

To cancel a program, press **X** when the Program screen you do not want is shown.

To change a program, press the appropriate button: **START+/-**, **STOP+/-**, **DATE+/-**, **PR+/-**, and/or **SP/LP/EP (///)** when the Program screen on which you want to make changes is shown.

5 Return to normal screen

Press **⏻ ?** repeatedly until no Program screen is shown.

6 Reengage timer recording standby mode

Press **⏻**. The recorder turns off automatically and "⏻" is displayed on the display panel.

- When "AUTO TIMER" is set to "ON", the timer recording standby mode automatically resumes when you turn off the recorder.

Program overlap warning display

If "PROGRAM OVERLAPPED" appears, you have another program overlapping the program you have just made. The Program Check screen appears and conflicting programs will start blinking.

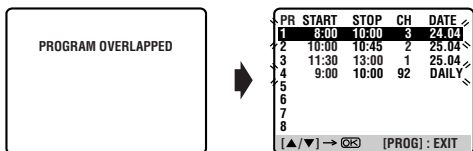

Example:
Program 1 (you have just made) and Program 4 overlap each other.

1 Select program to modify

Press Δ/∇ , then press \triangleright .

- You can only select one of the overlapping programs.
- If you do not mind this overlap, press **PROG** to finish the timer program setting. The program starting earlier or program with the lower program number will be recorded.

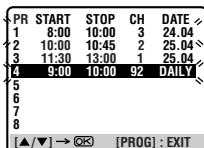

2 Cancel or change program setting

To cancel a program, press **X** when the Program screen you do not want is shown.

To change a program, press the appropriate button: **START+/-**, **STOP+/-**, **DATE+/-**, **PR+/-**, and/or **SP/LP/EP (///)** when the Program screen on which you want to make changes is shown, then press **OK**.

- If the overlap is not yet solved, the conflicting programs will be shown on the Program check screen. Repeat the above steps again.

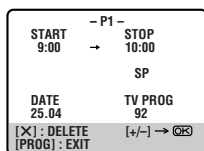

Other Functions

Checking tape position

When you change the recorder operation mode from the stop mode to fast forward or rewind mode, or when you perform an Index Search or Instant Review, the tape position indicator appears.

The position of "■" in relation to "0" (beginning) or "+" (end) shows you where you are on the tape.

- Set "O.S.D." to "ON".

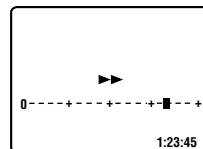

Changing display information

Each time you press **--:--**, the display panel shows the channel number and the clock time alternatively.

- You can change display in the stop, recording or recording pause mode, or during rewind/fast-forward high-speed search.
- When "O.S.D." is set to "ON" and **--:--** on the remote control is pressed, time counter will appear on the TV screen. To reset the time counter, press **0000** on the remote control.



Function settings

You can use the other useful function settings on the Function Set screen.

- Turn on the recorder and the TV, and set your TV to its AV mode or video channel.

1 Access Main Menu screen, then Function Set screen

Press **MENU** on the remote control. Press Δ/∇ to place the pointer next to "FUNCTION SET", then press **OK** or \triangleright .

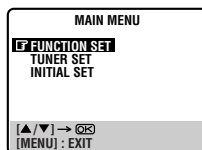

2 Select Function

Press Δ/∇ to place the pointer next to the function you want to set.

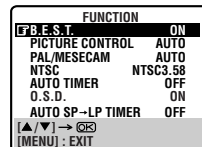

3 Change setting

Press **OK** or \triangleright . The default setting is **bold** in the following table. Press **MENU** to return to normal screen.

■ B.E.S.T. — ON / OFF

When B.E.S.T. (Biconditional Equalized Signal Tracking) system is set to "ON", this recorder checks the condition of the tape in use during playback and recording, and compensates to provide the highest-possible pictures. This takes place whenever you play back a tape or start recording after inserting a tape.

NOTE:

The recorder checks the tape condition for about 7 seconds, then starts recording. To make sure you record the desired scene or program completely, perform the following steps:

- 1 Press and hold **PAUSE** (II), and press **REC** (●). After about 7 seconds, the recorder re-enters Record Pause mode.
- 2 Press **PLAY** (▶) to start recording.

■ PICTURE CONTROL — AUTO(NORM) / EDIT / SOFT / SHARP

This function helps you to adjust the playback picture quality according to your preference.

AUTO (NORM): Normally select this. Picture quality is adjusted automatically. When "B.E.S.T." is "OFF", "NORM" will appear instead of "AUTO".

EDIT: Minimizes picture degradation during editing (recording and playback).

SOFT: Reduces image coarseness when viewing overlaid tapes containing much noise.

SHARP: Clearer, sharper-edged picture when viewing images with much flat, same-coloured surfaces such as cartoons.

NOTE:

Select "EDIT" when you are editing tapes. After you finish editing the tapes, select "AUTO".

■ PAL/MESECAM — AUTO / PAL / MESECAM

Select the appropriate colour system for recording or playback.

AUTO: Usually set to this mode. The appropriate colour system (PAL or MESECAM) will be selected depending on the playback or recording signals.

If the "AUTO" mode does not work properly, select either of the following manual modes.

PAL: To record PAL signals, or playback a PAL tape.

MESECAM: To record SECAM signals, or playback a SECAM or MESECAM tape.

NOTES:

- SECAM signals will always be recorded as MESECAM. Select "AUTO" or "MESECAM" when recording SECAM signals.
- When playing back a SECAM tape, select "AUTO" or "MESECAM". The playback picture will always be monochrome.

■ NTSC — NTSC3.58 / NTSC4.43 / NTSC→PAL

To record NTSC signals or playback a NTSC tape, it will be necessary to select the appropriate mode.

NTSC3.58: To record NTSC signals or playback a NTSC tape.

NTSC4.43: To record NTSC4.43 signals or playback a NTSC4.43 tape.

NTSC→PAL: To playback a NTSC tape on PAL TV.

NOTE:

- The "NTSC→PAL" mode does not work during recording. In this mode, NTSC signals will be recorded as NTSC3.58.
- The Menu screen is distorted during playing back a NTSC tape on PAL TV. Stop playback and access the Menu screen again.
- In the "NTSC4.43" mode, with some TVs, on-screen displays (Program screen, etc.) may roll up or down and there may be a loss of colour. When this happens, select the "NTSC3.58" mode.

■ AUTO TIMER — ON / OFF

● When this function is set to "ON":

The timer recording standby mode is automatically engaged when the recorder is turned off. It is temporarily canceled when the recorder is turned on. You do not have to press ⊖ to engage or disengage the timer recording standby mode.

● When this function is set to "OFF":

You have to press ⊖ to engage or disengage the timer recording standby mode.

■ O.S.D. — ON / OFF

When this function is set to "ON", various recorder status information (on-screen display) appears on the screen.

NOTE:

When you use this recorder as the source player for editing a tape, be sure to set this function to "OFF"; otherwise, the recorder status information (on-screen display) will be recorded on the edited tape.

■ AUTO SP→LP TIMER — ON / OFF

When this function is set to "ON", the recorder automatically switches to LP mode to allow complete recording if there is not enough tape to record the entire program while timer-recording in SP mode.

For Example, Recording a PAL-broadcast programme of 210 minutes in length onto a 180-minute tape.

Approximately 150 minutes Approximately 60 minutes

SP mode	LP mode
---------	---------

Total 210 minutes

NOTES:

- If you have programmed the recorder to timer-record 2 or more programs, do not use this function, but change the tape speed manually during timer programming.
- There may be some noise and sound disturbance where the tape speed switches from SP to LP mode on the tape.
- The Auto SP→LP Timer feature is not available during ITR (Instant Timer Recording), and the feature will not work properly with any tapes longer than E-180 or with some tapes of shorter lengths.

Multi-Brand Remote Control

This remote control can control some functions of remote controllable TVs, cable boxes, satellite receivers or DVD sets listed below. Without setting, you can control a JVC TV.

NOTES:

- Some unit's brands have more than one code. If the unit does not function with a specified code, try other codes.
- Depending on the type of unit, some or all functions cannot be operated using this remote control.
- It's not possible to operate a unit not equipped with a remote sensor.
- It's not possible to set the remote control for two units at the same time.
- Once you have set the remote control to operate the unit, you do not have to set it until you replace the batteries from the remote control.

TV Brand Setting

1 Turn on TV

Turn on the TV using the Power button on the TV or its remote control.

2 Set TV brand code

- 1 Press and hold **TV**.
- 2 Press the **Number keys** to enter your TV's brand code.
- 3 Press **OK**, and release **TV**. The TV should turn off.

3 Operate TV

First, press **TV** to set the remote control to TV mode, then press one of the following buttons: $\psi/1$, **TV/VCR**, **TV PR+/-**, MUTE (TV Muting), **TV** \triangleleft +/-, and the **Number keys**.

- For some brands, you must press **ENTER** after having pressed the **Number keys** to enter a channel number.

TV BRAND	CODE	TV BRAND	CODE
JVC	01, 23, 24, 25	mitsubishi	03
AIWA	36	MIVER	29
BEIJING	22	NEC	20
CCE	02	NOBLEX	22
CHANGHONG	34	NOKIA	31
DAEWOO	17, 37	PANASONIC	04, 11
FERGUSON	27	PEONY	34, 38, 39
FINLUX	30	PHILICO	10, 17, 21
FUNAI	32	PHILIPS	02, 42
GRADIENTE	15	SAMSUNG	12, 33, 34, 35
GRUNDIG	19	SANYO	13, 16
HITACHI	10	SHARP	06
ITT	28	SONY	07
JINXING	38	TCL	41
KONKA	40	THOMSON	26
LG/GOLDSTAR	18	TOSHIBA	08, 14

Cable Box, Satellite Receiver or DVD Brand Setting

1 Turn on the unit

Turn on the cable box, satellite receiver or DVD using the Power button on the unit or its remote control.

2 Enter brand code

- 1 Press and hold **CABLE/SAT/DVD**.
- 2 Press the **Number keys** to enter your unit's brand code.
- 3 Press **OK**, and release **CABLE/SAT/DVD**.

3 Operate the unit

First, press **CABLE/SAT/DVD** to set the remote control to cable box, satellite receiver or DVD mode, then press one of the following buttons:

For satellite receiver and cable box . . .

$\psi/1$, **TV PR+/-**, **Number keys**.

For DVD . . .

$\psi/1$, **PLAY** (\blacktriangleright), **STOP** (\blacksquare), **PAUSE** (\parallel), **FF** ($\blacktriangleright\blacktriangleright$), **REW** ($\blacktriangleleft\blacktriangleleft$), \triangleleft ($\blacktriangleleft\blacktriangleleft$) keys.

- For some brands, you must press **ENTER** after having pressed the **Number keys** to enter a channel number.
- To change the unit's channels, press **TV PR+/-** or the **Number keys**. (The **PR+/-** button can be used to change the recorder's channels only.)

CABLE BOX OR SATELLITE RECEIVER BRAND	CODE
JVC	72, 73
AMSTRAD	60, 61, 62, 63, 92
BT	72
CANAL+	81
CANAL SATELLITE	81
D-box	85
ECHOSTAR	51, 78, 79, 80, 82
FINLUX	68
GALAXIS	69, 88
GRUNDIG	64, 65
HIRSCHMANN	64
ITT	68
JERROLD	01, 04, 06, 11, 12, 15, 28, 75
KATHREIN	70, 71
LUXOR	68
MASPRO	70
NOKIA	68, 87
PACE	67, 86, 92
PANASONIC	13, 14, 74
PFT	69
PHILIPS	66, 84
PHONOTREND	69
SALORA	68
SKYMASTER	69
TPS	83
VIDEOWAY	03, 09, 22, 76, 77
WISI	64

DVD BRAND	CODE
JVC	55
PANASONIC	58
PHILIPS	56
TOSHIBA	57

Changing Remote Control Code

This remote control is capable of transmitting two control codes: one set to respond to A code control signals and another set to respond to B code control signals. This remote control is preset to send A code signals because your recorder is initially set to respond to A code signals. You can easily modify your recorder and the remote control to respond to B code signals. When using two JVC recorders, set two recorders and their remote controls to different codes, so that you can operate these recorders separately.

1 Set remote control code for remote control

- 1 Press and hold **VCR**.
- 2 Press the **Number key "2"**.
- 3 Press **OK**, and release **VCR**.

- The remote control now can transmit B code control signals.

2 Check remote control code for recorder

Press and hold **PLAY** (▶) on the recorder for more than 5 seconds while the recorder is turned off. The code currently set appears on the display panel.

3 Change code for recorder

Press any key on the remote control. The recorder now responds to B code control signals.

- To set the remote control and the recorder back to A code control signals, repeat the same procedure as shown above except pressing the **Number key "1"** in step 2 of 1.

To control two recorders with the same remote control

You can control two JVC recorders by switching the remote control code for the remote control between A and B (☞ step 1), keeping two recorders to different control codes.

- To change only the remote control code for the remote control, DO NOT perform steps 2 and 3.

Editing

You can use your recorder as the playback or recording deck. You can use a camcorder as the source player and your recorder as the recording deck. Refer also to the other components' instruction manuals for connection and its operations.

1 Make connections

Example: When using this recorder as the source player

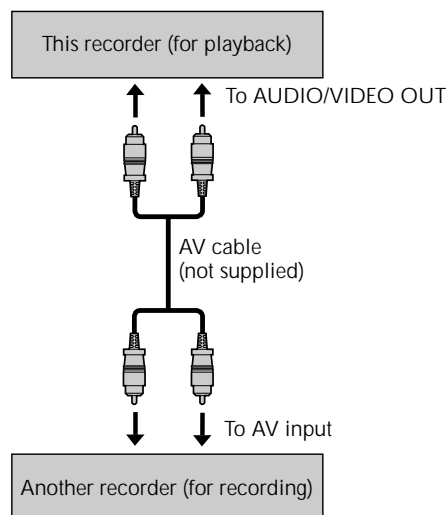

- When using this recorder as the recording deck, connect this recorder's AV input connectors to the AV output connectors on the other recorder. If the source player is monaural, connect the audio output connector on the source player to the left audio input connector on this recorder.

2 Load cassettes

Insert the playback cassette into the source player and the cassette to be recorded on into the recording deck.

3 Select input mode on recording deck

Select the correct external input on the recording deck. On this recorder (when using this recorder as the recording deck); Select "L-1" — when connecting the other recorder to the AV input connectors on the rear panel. Select "F-1" — when connecting the other recorder to the AV input connectors on the front panel.

On the remote control

Press **AUX** or **PR+/-**.

On the recorder

Press **PAUSE[PR]**, and then **FF[PR+]** or **REW[PR-]**. See step 2 in "Basic Recording".

4 Select edit mode

Set the edit mode to "ON" for the recorders if such a mode is equipped.

- On this recorder, set "PICTURE CONTROL" to "EDIT".

5 Start playback

Press **PLAY** (▶) on the source player.

6 Start recording

Press **REC** (●) on the recording deck.

Information on Multi-System Compatibility

Off-Air Recording

The built-in multi-system tuner is capable of receiving PAL B/G, I and D/K, and SECAM B/G and D/K broadcasts.

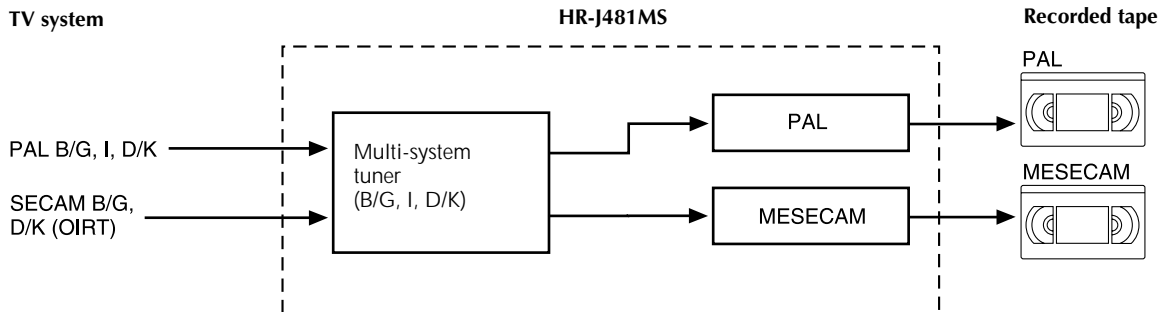

NOTE:

This model does not operate in BRAZIL (PAL-M) or ARGENTINA (PAL-N).

Playback

This recorder can play back all 3 types of recorded tape.

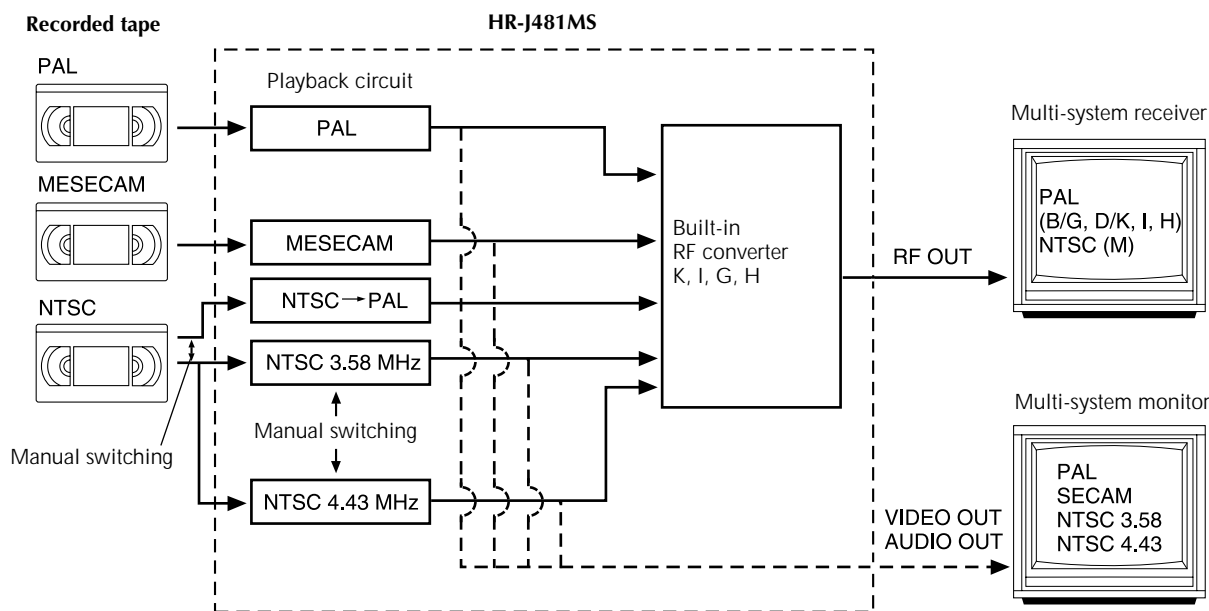

NOTES:

When viewing NTSC tapes on a PAL TV set:

- The picture may shrink vertically with black bars appearing at the top and bottom of the screen. This is not a malfunction on the part of the video recorder nor the TV.
- The picture may roll up or down. This can be corrected using the V-HOLD control found on some TVs. (This cannot be corrected if the TV does not have a V-HOLD control.)
- During search, still, or frame-by-frame playback, the picture will be distorted, and there may be a loss of colour.

ATTENTION:

When this recorder is connected to a multi-system TV, the audio signal may not be heard or may be noisy if the colour system select switch of the TV is adjusted to the AUTO position. In such a case, set the TV's colour system select switch to the appropriate position which corresponds to the TV system you have selected at the TV System Select screen.

Tape-To-Tape Editing

There are 4 different types of recorded tape, depending on the signal recorded.

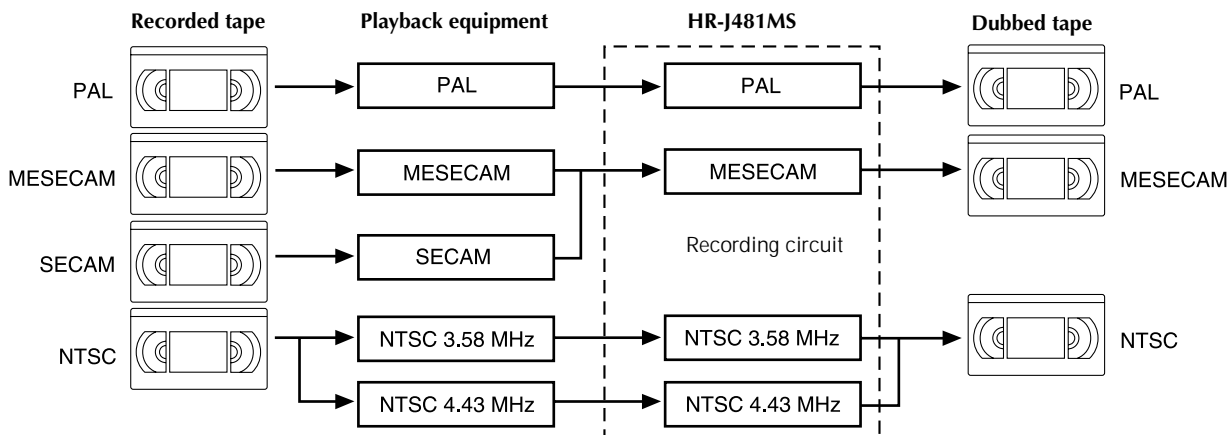

Tuner Setting

IMPORTANT

Perform the following steps only if auto channel set has not been set correctly by Auto Set Up function or if you have moved to a different area or if a new station starts broadcasting in your area.

Your recorder needs to memorise all necessary stations in channel positions in order to record TV programmes. Auto Channel Set automatically assigns all receivable stations in your area so that you can call them up with the **PR+/-** buttons without going through any vacant channels.

Auto Channel Set

1 Access Main Menu screen, then Tuner Set screen

Press **MENU** on the remote control. Press Δ/∇ to place the pointer next to "TUNER SET", then press **OK** or \triangleright .

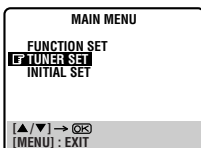

2 Perform Auto Channel Set

Press Δ/∇ to place the pointer next to "AUTO CH SET", then press **OK** or \triangleright .

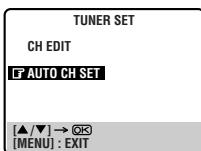

3 Select TV system

Press Δ/∇ to place the pointer next to the appropriate TV system, then press **OK** or \triangleright .

- Auto Channel Set will start.

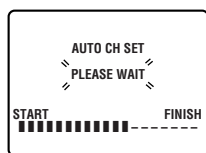
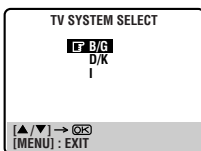

CH	FRQ	SYS	CH	FRQ	SYS
01	150	BG	07	229	BG
02	165	BG	08	237	BG
03	195	BG	09	355	BG
04	205	BG	10	366	BG
05	213	BG	11	374	BG
06	221	BG	12	384	BG

Navigation instructions at the bottom: [▲/▼] → [X] : DELETE, [▲/▼] → [OK] : EDIT, [MENU] : EXIT

Press **MENU** to return to normal screen.

IMPORTANT

- If no sound accompanies the picture or the audio sounds unnatural on some channels that have been stored by Auto Channel Set, the TV system setting for those channels may be incorrect. Select the appropriate TV system for those channels. Refer to "TV System Selection — When you see the picture but the audio can't be heard or sounds unnatural".
- Since your recorder memorises all detected stations even if the reception condition is poor, some of those stored stations may produce a noisy picture. To delete those stations, refer to "Delete A Channel".

Manual Channel Set

Store channels that were not stored during Auto Set Up or Auto Channel Set.

1 Access Tuner Set screen

Perform step 1 of "Auto Channel Set".

2 Access channel list

Press Δ/∇ to place the pointer next to "CH EDIT", then press **OK** or \triangleright .

3 Select position

Press Δ/∇ to place the pointer next to an open channel position, then press **OK** or \triangleright .

4 Select band

Press Δ/∇ to place the pointer next to the band of your choice, then press **OK** to initiate Manual Channel Set.

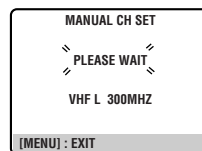
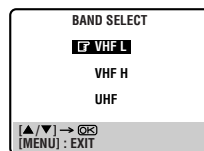

– Tuner Setting –

5 Set desired station

The screen to the right appears when a station is detected.

If you do not want to store the detected station...

Press \triangle/∇ to place the pointer next to "CONTINUE", then press **OK** or \triangleright .

Channel search will resume.

If you want to store the detected station...

Press \triangle/∇ to place the pointer next to "STORE", then press **OK** or \triangleright . The Channel List appears again.

- The blueback screen and the TV picture currently being broadcast appear alternately for 8 seconds each.
- If you want to store another channel, repeat steps **3** – **5**.
- When channel search completes for that band, the Band Select screen appears again. To set channels for other bands, select another band and start Manual Channel Set again (\leftarrow step **4** and **5**).

6 Return to normal screen

Press **MENU**.

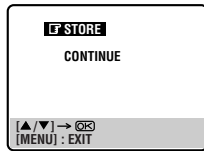

Delete A Channel

1 Access Tuner Set screen

Perform step **1** of "Auto Channel Set".

2 Access channel list

Press \triangle/∇ to place the pointer next to "CH EDIT", then press **OK** or \triangleright .

3 Select channel

Press \triangle/∇ to until the channel you want to delete begins blinking.

CH	FREQ	SYS	CH	FREQ	SYS
01	150	BG	07	229	BG
02	165	BG	08	237	BG
03	195	BG	09	355	BG
04	205	BG	10	365	BG
05	213	BG	11	374	BG
06	221	BG	12	384	BG

[▲/▼] → [X] : DELETE
[▲/▼] → [OK] : EDIT
[MENU] : EXIT

4 Delete channel

Press **X**.

- To re-store it, simply press \triangleleft .
- Repeat steps **3** and **4** as necessary.

5 Return to normal screen

Press **MENU**.

CH	FREQ	SYS	CH	FREQ	SYS
01	---	---	07	229	BG
02	165	BG	08	237	BG
03	195	BG	09	355	BG
04	205	BG	10	365	BG
05	213	BG	11	374	BG
06	221	BG	12	384	BG

[▲/▼] → [◀] : ADD
[MENU] : EXIT

Swap Channel Positions

Example: To swap CH03 and CH09.

1 Access Tuner Set screen

Perform step **1** of "Auto Channel Set".

2 Access channel list

Press \triangle/∇ to place the pointer next to "CH EDIT", then press **OK** or \triangleright .

3 Select position (e.g. 03)

Press \triangle/∇ until the section of CH "03" begins blinking, then press **OK** or \triangleright .

- Only "03" will blink.

CH	FREQ	SYS	CH	FREQ	SYS
01	150	BG	07	229	BG
02	165	BG	08	237	BG
03	195	BG	09	355	BG
04	205	BG	10	365	BG
05	213	BG	11	374	BG
06	221	BG	12	384	BG

[0 - 9] : INPUT CH
[OK] : FINE TUNING
[MENU] : EXIT

4 Select position (e.g. 09)

Press **Number keys** to input "0" and "9".

- The two selected channels will be swapped.
- To cancel the channel swapping, press \triangleleft .

CH	FREQ	SYS	CH	FREQ	SYS
01	150	BG	07	229	BG
02	165	BG	08	237	BG
03	355	BG	09	195	BG
04	205	BG	10	365	BG
05	213	BG	11	374	BG
06	221	BG	12	384	BG

[◀] : CANCEL
[OK]
[MENU] : EXIT

5 Store new positions

Press **OK** or \triangleright .

- Repeat steps **3** – **5** as necessary.

6 Return to normal screen

Press **MENU**.

Fine-Tuning Channels

1 Access Tuner Set screen

Perform step **1** of "Auto Channel Set".

2 Access channel list

Press \triangle/∇ to place the pointer next to "CH EDIT", then press **OK** or \triangleright .

3 Select channel to fine-tune

Press \triangle/∇ until the channel you want to tune begins blinking, then press **OK** twice.

- The "FRQ" number for that channel starts blinking.

CH	FREQ	SYS	CH	FREQ	SYS
01	150	BG	07	229	BG
02	165	BG	08	237	BG
03	195	BG	09	355	BG
04	205	BG	10	365	BG
05	213	BG	11	374	BG
06	221	BG	12	384	BG

[▲/▼] : FINE TUNING
[OK] : SELECT SYSTEM
[MENU] : EXIT

4 Perform tuning

Press \triangle/∇ until the picture becomes clearer, then press **OK** or \triangleright .

- Repeat steps **3** and **4** as necessary.

5 Return to normal screen

Press **MENU**.

TV System Selection — When you see the picture but the audio can't be heard or sounds unnatural

1 Access Tuner Set screen

Perform step **1** of "Auto Channel Set".

2 Access channel list

Press \triangle/∇ to place the pointer next to "CH EDIT", then press **OK** or \triangleright .

3 Select channel

Press \triangle/∇ until the channel you want to change its TV system begins blinking, then press **OK** three times.

- The "SYS" display for that channel starts blinking.

CH	FREQ	SYS	CH	FREQ	SYS
01	150	BG	07	229	BG
02	165	BG	08	237	BG
03	195	BG	09	355	BG
04	205	BG	10	365	BG
05	213	BG	11	374	BG
06	221	BG	12	384	BG

[▲/▼] : SELECT SYSTEM
[OK]
[MENU] : EXIT

4 Select TV system

Press \triangle/∇ to select the appropriate TV system (BG \rightarrow DK \rightarrow I).

- Repeat steps **3** and **4** as necessary.

5 Return to normal screen

Press **MENU**.

Specifications

GENERAL

Power requirement	
Rating	: AC 110 V – 240 V~, 50 Hz/60 Hz
Operating	: AC 90 V – 260 V~, 50 Hz/60 Hz
Power consumption	: 14 W
Temperature	
Operating	: 5°C to 40°C
Storage	: -20°C to 60°C
Operating position	: Horizontal only
Dimensions (W x H x D)	: 360 mm x 94 mm x 247 mm
Weight	: 2.9 kg
Format	: VHS standard
Maximum recording time	
(SP)	: 240 min. with E-240 video cassette (PAL/MESECAM)
	: 160 min. with T-160 video cassette (NTSC)
(LP)	: 480 min. with E-240 video cassette (PAL/MESECAM)
(EP)	: 480 min. with T-160 video cassette (NTSC)

VIDEO/AUDIO

Signal system	: PAL-type colour signal and CCIR monochrome signal, 625 lines 50 fields
	: NTSC colour and EIA monochrome signals, 525 lines/60 fields
Recording system	: DA-4 (Double Azimuth) head helical scan system
Signal-to-noise ratio	: 45 dB
Horizontal resolution	: 250 lines (PAL/MESECAM)
	: 220 lines (NTSC)
Frequency range	: 70 Hz to 10,00 0Hz
Input/Output	: RCA connectors (IN x 2, OUT x 1)

TUNER/TIMER

TV channel storage capacity	: 99 positions (+AUX position)
Tuning system	: Frequency synthesized tuner
Channel coverage	
VHF	: (Low) 42 MHz – 175 MHz (High) 175 MHz – 470 MHz
UHF	: 470 MHz – 870 MHz
Aerial output	: UHF channels (Adjustable E28 – E60)
Memory backup time	: Approx. 6 months Estimated figure based on supplied fresh battery; actual performance may differ.

ACCESSORIES

Provided accessories	: RF cable, Lithium battery CR2025, Infrared remote control unit, "R6/UM-3" battery x 2, Conversion plug*
----------------------	---

*Not provided in certain areas.

Specifications shown are for SP mode unless specified otherwise. E. & O.E. Design and specifications subject to change without notice.